



Corrugated Metal Hose & Braid

SPECIFICATION GUIDE

Your Trusted Source Worldwide

www.penflex.com

Exceptional Value

About Penflex

Penflex is a leading manufacturer of corrugated metal hose and braid products. Founded in 1902, Penflex Corporation has been a pioneer from the very beginning and continues today to be a leader in the design, and manufacture of flexible metal hose. Penflex hoses, known for their durability and superior resistance to corrosion, are used in more than 15 vertical markets, by hundreds of companies worldwide.

The Penflex Mission

It is our mission to be the manufacturer of choice by providing customers exceptional value:

- High quality flexible metal hose & braid
- Competitive pricing
- On-time delivery
- Superior and personalized customer service
- Cutting-edge industry expertise

Commitment to Distributors

Penflex views distributors as partners and remains committed to the traditional manufacturer-distributor relationship – a unique approach that allows Penflex to form lasting relationships with distributors, a relationship that goes beyond just the product. Penflex's corrugated hose products are available worldwide through selected fabricated distributors.

Product Offerings

Penflex provides a unique breadth and depth of highly durable products. Penflex products outlast competitive hoses, saving time and money in replacement costs and down time. Penflex is ISO 9001:2008 certified with a manufacturing process that creates high quality products providing greater durability and resistance to chemical corrosion from high pressure applications.

- Corrugated Metal Hose
- Series: P3, P4, 700, 800, 900, 400, 1400
- Interlocked Metal Hose
 - M100 - Unique pressure capable robust interlocked hose
 - Conveyor Hose
 - Exhaust Hose
- Wire & Synthetic Braids

Penflex also understands that unique applications require unique products and is committed to manufacturing products that distributors and end-users need. Penflex has the technology and know-how to create custom hose and braid products that meet specific application requirements.





Table of Contents

Specifying Part Numbers	Page 4
Chart Terminology	Page 5
P3 Stainless Steel Hose	Page 6
P4 Stainless Steel Hose	Page 7
Series 700 Stainless Steel Hose	Page 8
Series 800 Stainless Steel Hose	Page 9
Series 900 Stainless Steel Hose	Page 10
Series 1400 Stainless Steel Hose	Page 11
Series 740 Monel™ Hose	Page 12
Series C276 Hastelloy™ C276 Hose	Page 13
Series 625 Inconel™ 625 Hose	Page 14
Series 794 Bronze Hose	Page 15
Series 400 Stainless Helical Hose	Page 16
Technical Information	Page 17
<i>Selection Criteria</i>	<i>Page 17</i>
<i>Temperature Adjustment Factors</i>	<i>Page 18</i>
<i>Classification of Motion</i>	<i>Page 19</i>
<i>Maximizing the Safety and Effectiveness of an Assembly</i>	<i>Page 21</i>
<i>Glossary</i>	<i>Page 22</i>

This catalog is intended to serve as a reference. Please visit www.penflex.com for more information, including details on the specific Corrosion Resistance of Materials and Alloys Cross-Reference. For additional engineering specifications, please call the factory at (800) 232-3539 or (610) 367-2260. Penflex reserves the right to change specifications without notice.



Exceptional Value



Locations

In addition to its Gilbertsville, Pennsylvania headquarters and manufacturing plant location, Penflex maintains stocking warehouses in the USA and Europe. These satellite warehouses permit prompt deliveries to Penflex customers. Penflex Vietnam manufactures hose with primary service areas in the Asian markets.



Worldwide Locations

- Gilbertsville, Pennsylvania
- Atlanta, Georgia
- Chicago, Illinois
- Houston, Texas
- Los Angeles, California
- The Netherlands
- Vietnam

Quality Management System

Penflex is dedicated to providing superior quality in all that we do, from manufacturing high quality products to providing unsurpassed customer service to its distributors and end-users. Its Quality Management System, which complies with the requirements of ISO 9001:2008, is Penflex's commitment to each customer and end-user that quality and customer satisfaction come first. Penflex Quality Management System (Penflex QMS) is made up of the following parts:

- Quality Policy
- Quality Objectives
- Manual
- Procedures
- Forms
- Instructions

The Penflex Team

From last minute shipments and special requests to end-user support and custom orders, Penflex is committed to customer service, satisfaction and success. Penflex handles each customer's needs with a sense of urgency, consideration and professionalism. Penflex customer service professionals are available to answer questions and provide any assistance you may require.

Unmatched Support to Customers

Penflex has developed a set of technical tools to assist end-users and distributors in the selection and use of flexible metal hose products. These tools are available for your use at our website: <http://www.penflex.com/tools> and include on-line calculators for:

- Hose Assembly Length
- Corrugated Hose Flow Velocity
- Pressure
- Temperature Adjustment Factors
- Corrosion Resistance

To better support and serve the needs of our customers, Penflex posts Engineering Bulletins on its website. Engineering Bulletins are issued periodically to inform our customers about new products, changes to existing products, answers to the most common questions received from our customers, as well as relevant improvements to our manufacturing processes, etc. The Engineering Bulletins' archive can be viewed on our website: <http://www.penflex.com/bulletins>



The Penflex Product to Fit Your Requirements

Specifying Part Numbers for 400 / 700 / 800 / 900 / 1400 Series Products

7 2 1 - 0 0 4

Hose Type

4 = 400 Series
7 = 700 Series
8 = 800 Series
9 = 900 Series
14 = 1400 Series

Hose Alloy

04 = 304 Stainless steel
21 = 321 Stainless steel
16 = 316L Stainless steel
40 = Monel
94 = Bronze

Size

(See chart at right)

Size Code

004 = 1/4"
005 = 5/16"
006 = 3/8"
008 = 1/2"
010 = 5/8"
012 = 3/4"
016 = 1"
020 = 1-1/4"
024 = 1-1/2"
032 = 2"
040 = 2-1/2"
048 = 3"
056 = 3-1/2"
064 = 4"
080 = 5"
096 = 6"
128 = 8"
160 = 10"
192 = 12"
224 = 14"

Specifying Part Numbers for Braid

1 S B - 6 - 0 0 4

Braid Layers

0 = none
1 = 1 layer
2 = 2 layers

Braid Type

HHB = Series 400
SB = Series 700
SHB = Series 800
HTSB = Series 900
MB = Monel
BB = Bronze

Braid Alloy

(only used for 316 braid)
6 = 316L Stainless steel

Size

(See chart at right)

Specifying Part Numbers for Braided Hose-on-Reels

7 2 1 - 1 S B - 6 - 0 0 4

Hose/Braid Type

4 = 400 Series
7 = 700 Series
8 = 800 Series
9 = 900 Series

Braid Layers

0 = none
1 = 1 layer
2 = 2 layers

Braid Type

HHB = Series 400
SB = Series 500, 600, 700
SHB = Series 800
HTSB = Series 900
MB = Monel
BB = Bronze

Braid Alloy

(only used when ordering 316 braid)
6 = 316L Stainless steel

Size

(See chart at right)

Hose Alloy

04 = 304 Stainless steel
21 = 321 Stainless steel
16 = 316L Stainless steel
40 = Monel
94 = Bronze

Specifying Part Numbers for P3 and P4 Products

P3 - H3021 - B3004 - 0 0 4

Hose Series

Pitch

Blank = standard pitch
C = Compressed

Hose Alloy

16 = 316L Stainless Steel
21 = 321 Stainless Steel

Braid Layers

Blank = 1 Layer
2 = 2 Layers

Braid Alloy

04 = 304
16 = 316L

Size

(See Chart at right)

P4 - H4021 - B4004 - 0 0 4

Hose Series

Pitch

Blank = standard pitch
C = Compressed

Hose Alloy

16 = 316L Stainless Steel
21 = 321 Stainless Steel

Braid Layers

Blank = 1 Layer
2 = 2 Layers

Braid Alloy

04 = 304
16 = 316L

Size

(See Chart at right)

Chart Terminology

Nominal I.D.

The nominal interior dimension of the hose in inches.

Part Number

This column shows part numbers to be used when ordering.

Braid Layers

This column shows the number of wire braid covering(s) required for the indicated pressure rating.

Braid Construction

Term applies to description of braid, i.e., 36 x 9 x .016

36 = number of carriers or bands in a braid

9 = number of wires on each carrier

.016 = wire diameter in inches

Braid Coverage

The percentage of area covered by wire when referenced to the total cylinder surface area of the hose. 95% coverage means that only 5% of the area is not covered by wire.

Nominal O.D.

The nominal exterior dimension of the hose in inches.

Pressure Ratings

The maximum working, maximum test and nominal burst pressures for each hose size are shown with welded on fittings. All pressures listed in this catalog have been reduced by 20 percent to account for welding as the method of attachment.

Centerline Bend Radius – Dynamic

This column states, in inches, the minimum bend radius to which a hose may be bent when installed in conditions of motion that occur on a regular or intermittent basis.

Centerline Bend Radius – Static

This column states, in inches, the minimum bend radius to which a hose size may be bent when installed in conditions of no movement other than infrequent vibrations.

Weight

This column shows approximate weight per foot for each size and is given in pounds per foot.

P3 – Proven Performance in an Annular Corrugated Hose

ISO 10380
Qualified

P3 Series Stainless Steel Hose

Construction: Annular / Standard Pitch / Close Pitch
 Material: Hose: For 321, use H3021; For 316L, use H3016
 Braid: For 304, use B3004; For 316L, use B3016
 Characteristics: Light Weight /High Flexibility

Nom.I.D. (in.)	Part Number	Braid Layers	Braid Construction	Braid Coverage (%)	Nom.O.D. (IN.)	Maximum Pressure @70°F(PSIG)			Bend Radius (IN.)		Weight per Foot (LB.)
						Work	Test	Burst	Dynamic	Static	
1/4"	30xx-004	0			0.38	72	108	----			0.05
	P3-H30xx-B30xx-004	1	24 x 6 x .010	95	0.43	2,360	3,540	9,440	3.15	1.1	0.10
	P3-H30xx-2B30xx-004	2			0.48	2,832	4,248	11,328			0.15
5/16"	30xx-005	0			0.48	72	108	----			0.05
	P3-H30xx-B30xx-005	1	24 x 7 x .010	92	0.53	1,647	2,470	6,588	4.85	1.23	0.12
	P3-H30xx-2B30xx-005	2			0.58	1,976	2,964	7,904			0.19
3/8"	30xx-006	0			0.56	72	108	----			0.07
	P3-H30xx-B30xx-006	1	24 x 7 x .012	93	0.62	1,639	2,458	6,556	5.08	1.52	0.16
	P3-H30xx-2B30xx-006	2			0.68	1,967	2,950	7,868			0.25
1/2"	30xx-008	0			0.66	72	108	----			0.08
	P3-H30xx-B30xx-008	1	24 x 8 x .012	92	0.72	1,225	1,837	4,900	5.47	1.75	0.18
	P3-H30xx-2B30xx-008	2			0.78	1,470	2,205	5,880			0.28
5/8"	30xx-010	0			0.85	71	107	----			0.12
	P3-H30xx-B30xx-010	1	36 x 6 x .014	93	0.92	1,200	1,800	4,800	6.28	2.21	0.27
	P3-H30xx-2B30xx-010	2			0.99	1,440	2,160	5,760			0.42
3/4"	30xx-012	0			1.05	43	65	----			0.19
	P3-H30xx-B30xx-012	1	36 x 8 x .014	96	1.12	1,034	1,551	4,136	6.58	2.65	0.39
	P3-H30xx-2B30xx-012	2			1.19	1,241	1,861	4,964			0.59
1"	30xx-016	0			1.27	43	65	----			0.24
	P3-H30xx-B30xx-016	1	48 x 7 x .014	95	1.34	796	1,194	3,184	7.50	3.33	0.48
	P3-H30xx-2B30xx-016	2			1.41	955	1,433	3,820			0.68
1-1/4"	30xx-020	0			1.62	43	65	----			0.33
	P3-H30xx-B30xx-020	1	48 x 9 x .014	95	1.69	600	900	2,400	10.2	4.1	0.66
	P3-H30xx-2B30xx-020	2			1.76	720	1,080	2,880			0.99
1-1/2"	30xx-024	0			1.95	28	42	----			0.51
	P3-H30xx-B30xx-024	1	48 x 9 x .016	94	2.03	557	835	2,228	11.75	5.08	0.91
	P3-H30xx-2B30xx-024	2			2.11	668	1,002	2,672			1.31
2"	30xx-032	0			2.38	28	42	----			0.64
	P3-H30xx-B30xx-032	1	48 x 9 x .020	94	2.48	570	855	2,280	12.55	6.27	1.27
	P3-H30xx-2B30xx-032	2			2.58	684	1,026	2,736			1.90

a. Pressures listed have been reduced to account for welding as the method of attachment. Other methods such as brazing, neck-down designs or crimping will result in different pressures. Contact the factory for details.

P4 - The Newest Generation of Penflex Annular Corrugated Hose

ISO 10380
Qualified

P4 Series Braided Hose

Construction: Annular / Standard Pitch / Close Pitch
 Material: Hose: For 321, use H4021; For 316L, use H4016
 Braid: For 304, use B4004; For 316L, use B4016
 Characteristics: Medium Weight / Medium Flexibility
 High Coverage Braid

Nom.I.D. (in.)	Part Number	Braids	Braid Construction	Braid Coverage (%)	Nom.O.D. (IN.)	Maximum Pressure @70°F(PSIG)		Bend Radius (IN.)		Weight per Foot (LB.)
						Work	Burst	Dynamic	Static	
1/4"	40xx-004	0			0.40	200	----			0.08
	P4-H40xx-B40xx-004	1	24 x 5 x .014	98	0.48	2,500	10,000	5.00	1.00	0.17
	P4-H40xx-2B40xx-004	2			0.56	4,000	16,000			0.26
5/16"	40xx-005	0			0.48	180	----			0.09
	P4-H40xx-B40xx-005	1	24 x 6 x .014	98	0.57	2,200	8,800	5.00	1.00	0.19
	P4-H40xx-2B40xx-005	2			0.64	3,520	14,080			0.29
3/8"	40xx-006	0			0.63	100	----			0.13
	P4-H40xx-B40xx-006	1	24 x 8 x .014	98	0.70	1,530	6,120	5.50	1.25	0.27
	P4-H40xx-2B40xx-006	2			0.81	2,448	9,792			0.41
1/2"	40xx-008	0			0.82	80	----			0.23
	P4-H40xx-B40xx-008	1	24 x 9 x .014	94	0.89	1,200	4,800	6.00	1.50	0.39
	P4-H40xx-2B40xx-008	2			0.96	1,920	7,680			0.55
3/4"	40xx-012	0			1.21	70	----			0.39
	P4-H40xx-B40xx-012	1	36 x 9 x .014	95	1.28	850	3,400	8.00	2.25	0.62
	P4-H40xx-2B40xx-012	2			1.35	1,360	5,440			0.85
1"	40xx-016	0			1.51	40	----			0.53
	P4-H40xx-B40xx-016	1	36 x 10 x .014	92	1.58	590	2,360	9.00	2.75	0.79
	P4-H40xx-2B40xx-016	2			1.65	944	3,776			1.05
1-1/4"	40xx-020	0			1.85	25	----			0.76
	P4-H40xx-B40xx-020	1	48 x 8 x .016	92	1.93	540	2,160	10.50	3.50	1.12
	P4-H40xx-2B40xx-020	2			2.02	864	3,456			1.48
1-1/2"	40xx-024	0			2.19	20	----			0.84
	P4-H40xx-B40xx-024	1	48 x 10 x .016	93	2.28	475	1,900	12.00	4.00	1.29
	P4-H40xx-2B40xx-024	2			2.37	760	3,040			1.74
2"	40xx-032	0			2.60	15	----			0.90
	P4-H40xx-B40xx-032	1	48 x 10 x .020	95	2.72	530	2,120	15.00	5.00	1.61
	P4-H40xx-2B40xx-032	2			2.84	848	3,392			2.33
2-1/2"	40xx-040	0			3.23	12	----			1.16
	P4-H40xx-B40xx-040	1	72 x 8 x .020	94	3.33	410	1,640	20.00	8.00	1.86
	P4-H40xx-2B40xx-040	2			3.43	656	2,624			2.56
3"	40xx-048	0			3.78	10	----			1.21
	P4-H40xx-B40xx-048	1	72 x 9 x .020	93	3.88	335	1,340	22.00	9.00	2.00
	P4-H40xx-2B40xx-048	2			3.98	536	2,145			2.80
4"	40xx-064	0			4.85	8	----			1.69
	P4-H40xx-B40xx-064	1	72 x 11 x .020	91	4.98	240	960	27.00	13.00	2.68
	P4-H40xx-2B40xx-064	2			5.08	384	1,536			3.68

a. Pressures listed have been reduced to account for welding as the method of attachment. Other methods such as brazing, neck-down designs or crimping will result in different pressures. Contact the factory for details.

DS-EN-1000 (07)

Penflex's most widely used hose

Series 700 Stainless Steel Hose

Construction: Annular / Standard Pitch – Open Pitch & Compressed Pitch hose available upon request, consult factory
 Material: Hose: For 321, use 721; For 316L, use 716; For 304, use 704 (14" only)
 Braid: For 304, use 1SB; For 316L, use 1SB-6
 Characteristics: Medium Weight / Medium Flexibility

Nom. I.D. (IN.)	Part Number	Braid Layers	Braid Construction	Braid Coverage (%)	Nom. O.D. (IN.)	Maximum Pressure @70°F(PSIG) ^a			Centerline Bend Radius(IN.)		Weight per Foot (LB.)
						Working	Test	Nominal Burst	Dynamic	Static	
1/4"	7xx-004	0			.48	180	270	---			0.09
	7xx-1SB-004	1	24 x 5 x .014	89	.57	2,116	3,844	8,464	5.00	1.00	0.17
	7xx-2SB-004	2			.64	3,125	4,687	12,500			0.26
3/8"	7xx-006	0			.63	100	150	---			0.13
	7xx-1SB-006	1	24 x 7 x .014	91	.70	1,501	2,251	6,004	5.50	1.25	0.25
	7xx-2SB-006	2			.81	2,401	3,602	9,604			0.36
1/2"	7xx-008	0			.82	80	120	---			0.23
	7xx-1SB-008	1	24 x 7 x .014	82	.89	1,075	1,613	4,301	6.00	1.50	0.34
	7xx-2SB-008	2			.96	1,720	2,580	6,880			0.46
3/4"	7xx-012	0			1.21	70	105	---			0.39
	7xx-1SB-012	1	36 x 8 x .014	90	1.28	792	1,188	3,168	8.00	2.25	0.59
	7xx-2SB-012	2			1.35	1,267	1,901	5,069			0.79
1"	7xx-016	0			1.51	40	60	---			0.53
	7xx-1SB-016	1	36 x 9 x .014	85	1.58	571	857	2,285	9.00	2.75	0.75
	7xx-2SB-016	2			1.65	914	1,370	3,654			0.98
1-1/4"	7xx-020	0			1.85	25	38	---			0.76
	7xx-1SB-020	1	48 x 7 x .016	83	1.93	531	797	2,125	10.50	3.50	1.07
	7xx-2SB-020	2			2.02	850	1,274	3,398			1.37
1-1/2"	7xx-024	0			2.19	20	30	---			0.84
	7xx-1SB-024	1	48 x 9 x .016	87	2.28	472	708	1,887	12.00	4.00	1.23
	7xx-2SB-024	2			2.37	755	1,133	3,021			1.63
2"	7xx-032	0			2.60	15	23	---			0.90
	7xx-1SB-032	1	48 x 9 x .020	89	2.72	516	774	2,064	15.00	5.00	1.52
	7xx-2SB-032	2			2.84	826	1,239	3,302			2.14
2-1/2"	7xx-040	0			3.23	12	18	---			1.16
	7xx-1SB-040	1	72 x 7 x .020	86	3.33	387	581	1,548	20.00	8.00	1.86
	7xx-2SB-040	2			3.43	619	929	2,477			2.56
3"	7xx-048	0			3.78	10	15	---			1.21
	7xx-1SB-048	1	72 x 8 x .020	85	3.88	316	474	1,264	22.00	9.00	2.00
	7xx-2SB-048	2			3.98	506	758	2,022			2.80
3-1/2"	7xx-056	0			4.32	9	14	---			1.62
	7xx-1SB-056	1	72 x 10 x .020	84	4.45	297	445	1,188	24.00	10.00	2.61
	7xx-2SB-056	2			4.58	475	712	1,900			3.60
4"	7xx-064	0			4.85	8	12	---			1.69
	7xx-1SB-064	1	72 x 10 x .020	84	4.98	232	348	927	27.00	13.00	2.68
	7xx-2SB-064	2			5.10	371	557	1,485			3.68
5"	7xx-080	0			5.90	6	9	---			2.50
	7xx-1SB-080	1	72 x 8 x .025	74	6.03	191	286	764	31.00	18.00	3.75
	7xx-2SB-080	2			6.15	306	458	1,222			5.00
6"	7xx-096	0			6.87	5	8	---			3.47
	7xx-1SB-096	1	96 x 12 x .020	90	7.10	165	247	660	36.00	19.00	4.75
	7xx-2SB-096	2			7.33	264	396	1,056			6.04
8"	7xx-128	0			9.09	6	9	---			5.56
	7xx-1SB-128	1	96 x (21 x .024)	96	9.19	234	350	934	40.00	20.00	9.44
	7xx-2SB-128	2			9.28	374	561	1,495			13.36
10"	7xx-160	0			11.18	5	8	---			6.80
	7xx-1SB-160	1	96 x (25 x .028)	98	11.32	230	344	918	50.00	25.00	12.90
	7xx-2SB-160	2			11.45	367	551	1,469			19.00
12"	7xx-192	0			13.23	3	5	---			9.02
	7xx-1SB-192	1	96 x (25 x .028)	97	13.37	161	241	643	60.00	30.00	14.83
	7xx-2SB-192	2			13.50	257	386	1,029			20.64
14"	7xx-224	0			14.70	3	5	---			14.10
	7xx-1SB-224	1	96 x (25 x .028)	93	14.84	119	178	476	70.00	35.00	21.70
	7xx-2SB-224	2			14.98	190	285	760			29.30

a. Pressures listed have been reduced to account for welding as the method of attachment. Other methods such as brazing, neck-down designs or crimping will result in different pressures. Contact the factory for details.

Heavy Duty for Higher Pressure Applications and Longer Resistance to Chemical Corrosion

Series 800 Stainless Steel Hose

Construction: Annular / Close Pitch
 Material: Hose: For 321, use 821; For 316L, use 816
 Braid: For 304, use 1SHB; For 316L, use 1SHB-6
 Characteristics: Heavy Weight / Medium Flexibility

Nom. I.D. (IN.)	Part Number	Braid Layers	Braid Construction	Braid Coverage (%)	Nom. O.D. (IN.)	Maximum Pressure @70°F(PSIG) ^a			Centerline Bend Radius (IN.)		Weight per Foot (LB.)
						Working	Test	Nominal Burst	Dynamic	Static	
1/4"	8xx-004	0			.50	180	270	---	5.00	2.50	0.09
	8xx-1SHB-004	1	24 x 5 x .014	89	.57	2,562	3,844	10,250			0.17
	8xx-2SHB-004	2			.64	4,099	6,150	16,400			0.26
3/8"	8xx-006	0			.67	100	150	---	5.50	2.75	0.13
	8xx-1SHB-006	1	24 x 7 x .014	91	.74	1,501	2,251	6,004			0.25
	8xx-2SHB-006	2			.81	2,401	3,602	9,604			0.36
1/2"	8xx-008	0			.82	80	120	---	8.00	4.00	0.39
	8xx-1SHB-008	1	24 x 7 x .020	96	.92	2,194	3,291	8,777			0.63
	8xx-2SHB-008	2			1.02	3,510	5,265	14,040			0.87
3/4"	8xx-012	0			1.21	70	105	---	8.00	4.00	0.48
	8xx-1SHB-012	1	36 x 6 x .020	92	1.31	1,311	1,967	5,244			0.79
	8xx-2SHB-012	2			1.41	2,098	3,147	8,392			1.10
1"	8xx-016	0			1.50	40	60	---	9.00	4.50	0.79
	8xx-1SHB-016	1	36 x 8 x .020	95	1.60	1,069	1,604	4,276			1.20
	8xx-2SHB-016	2			1.70	1,710	2,566	6,840			1.61
1-1/4"	8xx-020	0			1.85	33	50	---	10.00	5.00	1.02
	8xx-1SHB-020	1	48 x 6 x .025	95	1.97	1,110	1,666	4,443			1.66
	8xx-2SHB-020	2			2.10	1,776	2,665	7,040			2.30
1-1/2"	8xx-024	0			2.17	20	30	---	10.00	5.00	1.36
	8xx-1SHB-024	1	48 x 7 x .025	95	2.30	868	1,302	3,472			2.11
	8xx-2SHB-024	2			2.43	1,388	2,082	5,552			2.86
2"	8xx-032	0			2.51	15	23	---	11.50	5.75	1.60
	8xx-1SHB-032	1	48 x 9 x .025	95	2.64	810	1,215	3,240			2.56
	8xx-2SHB-032	2			2.76	1,296	1,944	5,184			3.52
2-1/2"	8xx-040	0			3.23	10	15	---	24.00	12.00	2.00
	8xx-1SHB-040	1	72 x 7 x .025	96	3.36	578	867	2,312			3.12
	8xx-2SHB-040	2			3.49	925	1,387	3,700			3.30
3"	8xx-048	0			3.78	10	15	---	28.00	14.00	2.97
	8xx-1SHB-048	1	72 x 9 x .025	88	3.91	540	810	2,160			4.42
	8xx-2SHB-048	2			4.03	864	1,295	3,456			5.87
4"	8xx-064	0			4.81	8	12	---	40.00	20.00	3.10
	8xx-1SHB-064	1	72 x 9 x .025	89	4.93	333	500	1,332			4.55
	8xx-2SHB-064	2			5.05	533	800	2,132			6.00
6"	8xx-096	0			6.87	5	8	---	48.00	24.00	3.85
	8xx-1SHB-096	1	96 x (13 x .025)	89	7.10	266	398	1,062			6.45
	8xx-2SHB-096	2			7.33	425	638	1,700			9.05

a. Pressures listed have been reduced to account for welding as the method of attachment. Other methods such as brazing, neck-down designs or crimping will result in different pressures. Contact the factory for details.

Heavy Duty for Extreme Pressure Applications and Longer Resistance to Chemical Corrosion



Series 900 Stainless Steel Hose

Construction: Annular / Close Pitch
 Material: Hose: 316L Stainless Steel
 Braid: 304L Stainless Steel
 Characteristics: Heavy Weight / Medium Flexibility

Nom. I.D. (IN.)	Part Number	Braid Layers	Braid Construction	Braid Coverage	Nom. O.D. (IN.)	Maximum Pressure @70°F(PSIG) ^a			Centerline Bend Radius (IN.)		Weight per Foot (LB.)
						Working	Test	Nominal Burst	Dynamic	Static	
1/4"	916-004	0			.50	180	270	----			0.20
	916-1HTSB-004	1	24 x 4 .016	83	.58	2,754	4,131	11,017	12.00	6.00	0.28
	916-2HTSB-004	2			.64	4,406	6,609	17,627			0.36
3/8"	916-006	0			.67	100	150	----			0.31
	916-1HTSB-006	1	24 x 6 x .016	89	.75	1,921	2,881	7,682	12.00	6.00	0.43
	916-2HTSB-006	2			.83	3,073	4,610	12,291			0.55
1/2"	916-008	0			.82	80	120	----			0.40
	916-1HTSB-008	1	24 x 7 x .020	96	.92	2,194	3,291	8,777	14.00	7.00	0.58
	916-2HTSB-008	2			1.02	3,510	5,265	14,040			0.76
3/4"	916-012	0			1.22	70	105	----			0.65
	916-1HTSB-012	1	48 x 4 x .024	93	1.34	1,994	2,991	7,980	15.00	7.50	0.92
	916-2HTSB-012	2			1.46	3,192	4,788	12,769			1.19
1"	916-016	0			1.52	40	60	----			1.02
	916-1HTSB-016	1	48 x 5 .024	94	1.65	1,599	2,398	6,397	16.00	8.00	1.48
	916-2HTSB-016	2			1.77	2,558	3,830	10,234			1.94
1-1/4"	916-020	0			1.85	25	38	----			1.56
	916-1HTSB-020	1	48 x 6 x .024	93	1.97	1,317	1,975	5,270	18.00	9.00	2.02
	916-2HTSB-020	2			2.09	2,107	3,161	8,431			2.48
1-1/2"	916-024	0			2.19	20	30	----			2.01
	916-1HTSB-024	1	48 x 7 x .024	93	2.31	1,062	1,592	4,247	19.00	9.50	2.65
	916-2HTSB-024	2			2.43	1,698	2,547	6,795			3.30
2"	916-032	0			2.51	15	23	----			2.43
	916-1HTSB-032	1	48 x 8 x .024	93	2.64	842	1,262	3,368	24.00	12.00	3.17
	916-2HTSB-032	2			2.77	1,346	2,019	5,388			3.91

a. Pressures listed have been reduced to account for welding as the method of attachment. Other methods such as brazing, neck-down designs or crimping will result in different pressures. Contact the factory for details.

1400 Stainless Steel Series – Designed for Extreme Pressure Applications

1400 Metal Hose and Braid

Construction: Annular / Close Pitch
 Hose Material: 316L SS
 Braid: 316L SS
 Characteristics: Heavy Weight / Reduced Flexibility

Nom. Size (IN.)	Part Number	Braids	Nom. OD (IN.)	Braid Construction	Max. Pressure* @70 ° F (PSIG)			Min. Bend Radius (IN.) Dynamic**	Weight per Foot (LB.)
					WORK	TEST	BURST		
3"	1416-3SHB-6-048	3	4.22	72 x 9 x .025	1,250	1,875	5,000	84.00	8.70
4"	1416-4SHB-6-064	4	5.27	72 x 10 x .024	1,250	1,875	5,000	112.00	10.48

Note:

Use of flexible metal hose in high pressure applications should be undertaken only after through engineering analysis, prototyping and approval by the end-user.

* It is recommended that every fabricating distributor perform their own testing to verify that their assembly and welding procedures are sufficient to meet the design pressure ratings of the 1400 series.

** Minimum bend radius is based on theoretical calculations



Monel

Series 740 Monel™ Hose

Construction: Annular / Standard Pitch
 Material: Hose: 400 Monel
 Braid: 400 Monel
 Characteristics: Medium Weight / Medium Flexibility

Nom. I.D. (IN.)	Part Number	Braid Layers	Braid Construction	Braid Coverage (%)	Nom. O.D. (IN.)	Maximum Pressure @70°F(PSIG) ^{ab}			Centerline Bend Radius (IN.)		Weight per Foot (LB.)
						Working	Test	Nominal Burst	Dynamic	Static	
1/4"	740-004	0			.50	144	216	---			0.09
	740-1MB-004	1	24 x 4 x .016	84	.58	1,722	2,583	6,888	5.00	2.50	0.19
	740-2MB-004	2			.66	2,755	4,133	11,021			0.29
1/2"	740-008	0			.82	64	96	---			0.39
	740-1MB-008	1	24 x 5 x .016	72	.90	741	1,112	2,964	8.00	4.00	0.63
	740-2MB-008	2			.98	1,186	1,778	4,742			0.87
3/4"	740-012	0			1.21	156	84	---			0.48
	740-1MB-012	1	36 x 6 x .016	82	1.29	629	944	2,516	8.00	4.00	0.79
	740-2MB-012	2			1.38	1,006	1,510	4,026			1.10
1"	740-016	0			1.50	32	48	---			0.79
	740-1MB-016	1	36 x 8 x .016	86	1.58	517	776	2,068	9.00	4.50	1.00
	740-2MB-016	2			1.66	827	1,241	3,309			1.20
1-1/2"	740-024	0			2.19	16	24	---			0.84
	740-1MB-024	1	48 x 9 x .016	87	2.27	343	515	1,372	12.00	6.00	1.28
	740-2MB-024	2			2.35	549	823	2,195			1.72
2"	740-032	0			2.51	12	18	---			1.04
	740-1MB-032	1	48 x 14 x .016	97	2.59	376	564	1,504	15.00	7.50	1.72
	740-2MB-032	2			2.67	602	758	2,022			2.40
3"	740-048	0			3.78	8	12	---			1.21
	740-1MB-048	1	48 x 11 x .020	82	3.88	211	317	844	22.00	11.00	2.04
	740-2MB-048	2			3.98	338	506	1,350			2.87

- a. Pressures listed have been reduced to account for welding as the method of attachment. Other methods such as brazing, neck-down designs or crimping will result in different pressures. Contact the factory for details.
- b. For chlorine transfer applications, consult factory for additional data.

Alloy C276 Annular Corrugated Hose – Designed for the Most Aggressive Media Applications

Hastelloy™ C276 Braided Hose Data

Hastelloy C276 metal hose is a high quality industrial hose made of the alloy which is among the most corrosion resistant alloys currently available. This hose is commonly used in Power Generation, Steel, Chemical, Oil and Gas & other industries.

Construction: Annular / Standard Pitch
 Material: Hose: Hastelloy C276
 Braid: Hastelloy C276

Nom.I.D. (in.)	Part Number	Braids	Braid Construction	Braid Coverage (%)	Nom.O.D. (IN.)	Maximum Pressure @ 70°F (PSIG)		Bend Radius (IN.)		Weight per Foot (LB.)
						Work	Burst	Dynamic	Static	
1/2"	776-008	0			0.82	80	----			0.25
	776-1SBX-C276-008	1	24 x 8 x .016	82	0.89	1,075	4,301	5.00	2.50	0.38
	776-2SBX-C276-008	2			0.96	1,720	6,880			0.51
3/4"	776-012	0			1.21	70	----			0.43
	776-1SBX-C276-012	1	36 x 8 x .016	90	1.28	792	3,168	6.00	3.00	0.65
	776-2SBX-C276-012	2			1.35	1,267	5,069			0.87
1"	776-016	0			1.51	40	----			0.58
	776-1SBX-C276-016	1	36 x 10 x .016	85	1.58	571	2,285	7.30	3.65	0.83
	776-2SBX-C276-016	2			1.65	916	3,664			1.08
1-1/2"	776-024	0			2.19	20	----			0.92
	776-1SBX-C276-024	1	48 x 8 x .020	87	2.28	472	1,887	8.60	4.30	1.35
	776-2SBX-C276-024	2			2.37	755	3,021			1.79
2"	776-032	0			2.60	15	----			1.00
	776-1SBX-C276-032	1	48 x 10 x .020	89	2.72	516	2,064	12.00	6.00	1.67
	776-2SBX-C276-032	2			2.84	826	3,302			2.35

Pressures listed have been reduced to account for welding as the method of attachment. Other methods such as brazing, neck-down designs or crimping will result in different pressures. Contact the factory for details.

Alloy 625 Annular Corrugated Hose – Superior Resistance to a Wide Range of Corrosive Environments

Inconel™ 625 Hose

Construction: Annular / Standard Pitch

Material: Hose: Inconel alloy 625

Braid: Inconel alloy 625

Characteristics: Medium weight / Medium flexibility; 700-series geometry

Nom. I.D. (IN.)	Part Number	Braid Layers	Braid Construction	Braid Coverage (%)	Nom. O.D. (IN.)	Maximum Pressure @70°F(PSIG) ^a			Centerline Bend Radius(IN.)		Weight per Foot (LB.)
						Working	Test	Nominal Burst	Dynamic	Static	
1/4"	625-004	0			.48	180	270	----	5.00	1.00	0.09
	625-11B-004	1	24 x 5 x .014	89	.57	2,116	3,844	8,464			0.17
	625-21B-004	2			.64	3,125	4,687	12,500			0.26
3/8"	625-006	0			.63	100	150	----	5.50	1.25	0.13
	625-11B-006	1	24 x 7 x .014	91	.70	1,501	2,251	6,004			0.25
	625-21B-006	2			.81	2,401	3,602	9,604			0.36
1/2"	625-008	0			.82	80	120	----	6.00	1.50	0.23
	625-11B-008	1	24 x 7 x .014	82	.89	1,075	1,613	4,301			0.34
	625-21B-008	2			.96	1,720	2,580	6,880			0.46
3/4"	625-012	0			1.21	70	105	----	8.00	2.25	0.39
	625-11B-012	1	36 x 8 x .014	90	1.28	792	1,188	3,168			0.59
	625-21B-012	2			1.35	1,267	1,901	5,069			0.79
1"	625-016	0			1.51	40	60	----	9.00	2.75	0.53
	625-11B-016	1	36 x 9 x .014	85	1.58	571	857	2,285			0.75
	625-21B-016	2			1.65	914	1,370	3,654			0.98
1-1/4"	625-020	0			1.85	25	38	----	10.50	3.50	0.76
	625-11B-020	1	48 x 7 x .016	83	1.93	531	797	2,125			1.07
	625-21B-020	2			2.02	850	1,274	3,398			1.37
1-1/2"	625-024	0			2.19	20	30	----	12.00	4.00	0.84
	625-11B-024	1	48 x 9 x .016	87	2.28	472	708	1,887			1.23
	625-21B-024	2			2.37	755	1,133	3,021			1.63
2"	625-032	0			2.60	15	23	----	15.00	5.00	0.90
	625-11B-032	1	48 x 9 x .020	89	2.72	516	774	2,064			1.52
	625-21B-032	2			2.84	826	1,239	3,302			2.14
2-1/2"	625-040	0			3.23	12	18	----	20.00	8.00	1.16
	625-11B-040	1	72 x 7 x .020	86	3.33	387	581	1,548			1.86
	625-21B-040	2			3.43	619	929	2,477			2.56
3"	625-048	0			3.78	10	15	----	22.00	9.00	1.21
	625-11B-048	1	72 x 8 x .020	85	3.88	316	474	1,264			2.00
	625-21B-048	2			3.98	506	758	2,022			2.80
3-1/2"	625-056	0			4.32	9	14	----	24.00	10.00	1.62
	625-11B-056	1	72 x 10 x .020	84	4.45	297	445	1,188			2.61
	625-21B-056	2			4.58	475	712	1,900			3.60
4"	625-064	0			4.85	8	12	----	27.00	13.00	1.69
	625-11B-064	1	72 x 10 x .020	84	4.98	252	348	927			2.68
	625-21B-064	2			5.10	371	557	1,485			3.68

- a. Pressures listed have been reduced to account for welding as the method of attachment. Other methods such as brazing, neck-down designs or crimping will result in different pressures. Contact the factory for details.

Bronze

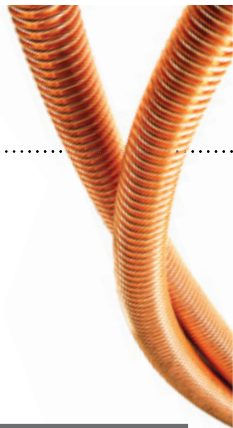

Series 794 Bronze Hose

Construction: Annular / Standard Pitch
 Material: Hose: Bronze
 Braid: Bronze
 Characteristics: Medium Weight / Medium Flexibility

Nom. I.D. (IN.)	Part Number	Braid Layers	Braid Construction	Braid Coverage (%)	Nom. O.D. (IN.)	Maximum Pressure @70°F(PSIG) ^a			Centerline Bend Radius (IN.)		Weight per Foot (LB.)
						Working	Test	Nominal Burst	Dynamic	Static	
1/4"	794-004	0			.49	100	150	----			0.13
	794-1BB-004	1	24 x 4 x .016	84	.57	1,035	1,553	4,142	5.50	1.00	0.23
	794-2BB-004	2			.65	1,656	2,649	6,627			0.33
3/8"	794-006	0			.67	40	75	----			0.25
	794-1BB-006	1	24 x 5 x .016	81	.75	685	1,027	2,738	6.00	1.25	0.36
	794-2BB-006	2			.83	1,096	1,644	4,381			0.47
1/2"	794-008	0			.82	40	60	----			0.38
	794-1BB-008	1	36 x 8 x .016	94	.90	706	1,059	2,825	7.00	1.50	0.57
	794-2BB-008	2			.98	1,130	1,695	4,520			0.76
3/4"	794-012	0			1.21	30	36	----			0.50
	794-1BB-012	1	36 x 6 x .020	92	1.31	577	865	2,307	8.00	2.25	0.83
	794-2BB-012	2			1.41	923	1,384	3,691			1.16
1"	794-016	0			1.51	20	30	----			0.68
	794-1BB-016	1	36 x 8 x .020	95	1.61	470	705	1,881	10.00	3.00	1.12
	794-2BB-016	2			1.71	752	1,128	3,009			1.56
1-1/4"	794-020	0			1.85	15	23	----			0.80
	794-1BB-020	1	48 x 7 x .020	93	1.95	361	541	1,443	12.00	3.50	1.31
	794-2BB-020	2			2.05	577	865	2,309			1.82
1-1/2"	794-024	0			2.18	10	15	----			1.03
	794-1BB-024	1	48 x 6 x .025	89	2.31	329	493	1,317	13.50	4.00	1.73
	794-2BB-024	2			2.43	526	789	2,107			2.43
2"	794-032	0			2.50	8	12	----			1.81
	794-1BB-032	1	48 x 8 x .025	92	2.63	317	475	1,267	17.00	5.00	2.73
	794-2BB-032	2			2.75	507	760	2,027			3.65
2-1/2"	794-040	0			3.18	8	12	----			1.39
	794-1BB-040	1	48 x 11 x .025	97	3.31	272	408	1,090	22.00	8.00	2.66
	794-2BB-040	2			3.43	435	653	1,744			3.93
3"	794-048	0			3.65	10	15	----			1.44
	794-1BB-048	1	48 x 11 x .025	92	3.78	201	301	805	24.00	12.00	2.84
	794-2BB-048	2			3.91	322	482	1,288			4.11
4"	794-064	0			4.81	8	12	----			3.45
	794-1BB-064	1	72 x 9 x .025	90	4.94	142	213	568	26.00	14.00	5.03
	794-2BB-064	2			5.06	227	341	909			6.61

a. Pressures listed have been reduced to account for welding as the method of attachment. Other methods such as brazing, neck-down designs or crimping will result in different pressures. Contact the factory for details.

Helical Hose

Series 400 Stainless Steel Hose

Construction: Helical / Standard Pitch
 Material: Hose: For 304, use 404; For 316L, use 416
 Braid: 304L Stainless Steel
 Characteristics: Medium Weight / Medium Flexibility

Nom. I.D. (IN.)	Part Number	Braid Layers	Braid Construction	Braid Coverage (%)	Nom. O.D. (IN.)	Maximum Pressure @70°F(PSIG) ^a			Centerline Bend Radius (IN.)		Weight per Foot (LB.)
						Working	Test	Nominal Burst	Dynamic	Static	
1/4"	4xx-004	0			.43	180	270	---	---	---	0.07
	4xx-1HHB-004	1	24 x 6 x .012	98	.50	1,987	2,980	7,950	5.00	1.00	0.15
	4xx-2HHB-004	2			.58	3,125	4,687	12,500	---	---	0.23
3/8"	4xx-006	0			.59	100	150	---	---	---	0.11
	4xx-1HHB-006	1	24 x 8 x .012	98	.66	1,750	2,800	7,000	5.50	1.00	0.21
	4xx-2HHB-006	2			.74	2,800	4,200	11,200	---	---	0.32
1/2"	4xx-008	0			.73	80	120	---	---	---	0.15
	4xx-1HHB-008	1	24 x 8 x .012	87	.80	1,100	1,650	4,400	6.50	1.50	0.25
	4xx-2HHB-008	2			.87	1,760	2,640	7,040	---	---	0.35
3/4"	4xx-012	0			1.00	52	78	---	---	---	0.22
	4xx-1HHB-012	1	36 x 8 x .012	91	1.07	825	1,237	3,300	8.00	1.50	0.37
	4xx-2HHB-012	2			1.15	1,320	1,979	5,280	---	---	0.52
1"	4xx-016	0			1.28	30	45	---	---	---	0.27
	4xx-1HHB-016	1	36 x 8 x .016	93	1.37	800	1,200	3,200	8.75	1.75	0.53
	4xx-2HHB-016	2			1.46	1,280	1,920	5,120	---	---	0.80

a. Pressures listed have been reduced to account for welding as the method of attachment. Other methods such as brazing, neck-down designs or crimping will result in different pressures. Contact the factory for details.



PENFLEX

Selection Criteria

The selection of flexible metal hose for a particular application is influenced by six primary considerations:

- Temperature
- Pressure
- Media
- Size
- End Fittings
- Motion

To make the best choice for a specific application, consider all the relevant operating factors against the properties of the various types of flexible metal hoses.

Temperature

The physical properties of any material varies with temperature. Limits for operating temperature are affected by the working pressure, the type of media being conveyed and the nature of the application. By careful selection of material, it is possible to provide flexible metal hose for a wide range of operating temperatures. The choice of hose type, metal alloy, end fitting and method of fitting attachment determines the temperature limit.

Pressure

The nominal pressure ratings of flexible metal hose varies according to type, material and size. Specific pressure ratings for each type of flexible metal hose are found in each section of this catalog. Under actual working conditions, pressure is affected by many other factors such as temperature, pulsating conditions and bending stresses.

Media

The type of media being conveyed is an important consideration in the selection process. Metal hose is subject to corrosion by both the material flowing through it and the outside environment. For almost all applications, a metal hose can be selected that is resistant to the intended media. Since metal hose is a thin-walled product, it will not have the same total life as heavier walled tube or pipe of the same material.

For Corrosion Resistance of Materials to different environment, refer to a chart posted on our web site:

<http://www.penflex.com/corrosion>

Size

The size of flexible metal hose is specified by the nominal diameter. The existing piping will normally dictate the size of the metal hose for a particular application. However, flow rate, velocity and pressure drop considerations may also influence the selection of the hose size.

End Fittings

The use of flexible metal hose is complimented by the extensive range of end fittings that are available. Such end fittings may be male or female pipe threads, unions, flanges, flared tube fittings or other specially designed connectors. End fittings are attached by welding, silver brazing, soldering and occasionally by mechanical means, depending on the type of hose and the alloy. For further detail on the appropriate type of end fitting please consult your fabricating distributor.

Motion

Flexible metal hose is generally used in four types of applications.

- To correct problems of misalignment.
- To provide flexibility in manual handling operations.
- To compensate for regular or constant movement.
- To absorb vibration.

In all types, careful hose selection, design of the assembly and installation are important for optimal service life. The flexibility of a hose is determined by its mechanical design and the inherent flexibility of its material.

Temperature

Temperature Adjustment Factors

In general, the strength and therefore the pressure rating of metal hose decreases as the temperature increases. Thus, as the operating temperature of a metal hose assembly increases, the maximum allowable working pressure of the assembly decreases. The pressure ratings shown in the specifications charts for corrugated and interlocked hose are valid at 70°F. Elevated service temperatures will decrease these pressure ratings by the factors shown in the following chart for the alloy used in the braid wire. What also must be considered is the maximum working temperature of the end fittings, of the hose and their method of attachment.

For example to calculate the maximum working pressure for:

- 3/4" ID, 321 stainless steel corrugated hose
- with single-braided, 304L braid
- at 800°F.

From the corrugated metal hose specification table, the maximum working pressure at 70°F is 792 PSIG. Multiply 792 PSIG by 0.73.

The maximum working pressure at 800°F is 578 PSIG.

Temperature Adjustment Factor Based on Braid Alloy

Temperature (°F)	304/304L Stainless Steel	316 L Stainless Steel	321 Stainless Steel	Carbon Steel	Monel	Bronze
70	1.00	1.00	1.00	1.00	1.00	1.00
150	.95	.93	.97	.99	.93	.92
200	.91	.89	.94	.97	.90	.89
250	.88	.86	.92	.96	.87	.86
300	.85	.83	.88	.93	.83	.83
350	.81	.81	.86	.91	.82	.81
400	.78	.78	.83	.87	.79	.78
450	.77	.78	.81	.86	.77	.75
500	.77	.77	.78	.81	.73	----
600	.76	.76	.77	.74	.72	----
700	.74	.76	.76	.66	.71	----
800	.73	.75	.68	.52	.70	----
900	.68	.74	.62	----	----	----
1,000	.60	.73	.60	----	----	----
1,100	.58	.67	.58	----	----	----
1,200	.53	.61	.53	----	----	----
1,300	.44	.55	.46	----	----	----
1,400	.35	.48	.42	----	----	----
1,500	.26	.39	.37	----	----	----

Saturated Steam Pressure To Temperature (PSIG)

Saturated Steam (PSIG)	Temp (°F)	Saturated Steam (PSIG)	Temp (°F)	Saturated Steam (PSIG)	Temp (°F)
0	212	150	366	450	460
10	238	175	377	475	465
20	259	200	388	500	470
30	274	225	397	550	480
40	287	250	406	600	489
50	298	275	414	700	505
60	307	300	422	800	520
75	320	325	429	900	534
80	324	350	436	1000	546
90	331	375	442	1250	574
100	338	400	448	1500	606
125	353	425	454	2500	669

Saturated Steam Pressure To Temperature (Hg)

Saturated Steam Vacuum (in. of Hg)	Temp (°F)
----	0
29.84	20
29.74	32
29.67	40
29.39	60
28.89	80
27.99	100
26.48	120
24.04	140
20.27	160
15.20	180
6.46	200

Pressure Loss and Flow Velocity Information

Pressure Loss

For the same flow characteristics, the pressure loss is higher in metal hoses than rigid piping, due to the profile of the corrugations. As a rough estimation, expect the pressure loss in corrugated hoses to be 150 percent higher than in new, smooth steel pipes.

Classification of Motion

Random Motion

Such motion is non-predictable and occurs from the manual handling of a hose assembly. Care must be taken to prevent over-bending of the hose and to avoid external abrasion of the wire braid. An armor covering of interlocked hose provides protection against these abuses.

Axial Motion

This type of motion occurs when there is extension or compression of the hose along its longitudinal axis. This class of motion is restricted to unbraided corrugated hose only and is accommodated by traveling loops (see pg. 18) or bellows specifically designed for this purpose.

Angular Motion

This type of motion occurs when one end of a hose assembly is deflected in a simple bend with the ends not remaining parallel.

To find the live hose length:

$$L = \pi R\theta / 180 + 2(s)$$

L = Live Hose Length (inches)

$\pi = 3.1416$

R = Minimum Centerline Bend Radius – Dynamic (in.)

θ = Angular Deflection (degrees)

S = Outside Diameter of Hose

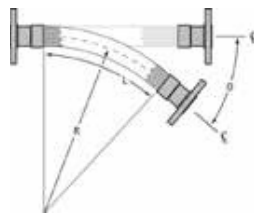

Offset Motion

Offset motion occurs when one end of the hose assembly is deflected in a plane perpendicular to the longitudinal axis with the ends remaining parallel. This movement can be due to a one-time (static) bend or movement which repeatedly occurs slowly over time (such as thermal expansion).

- The appropriate formula to use to calculate Live Hose Length depends on the condition of the moving end.
- When the offset motion occurs to both sides of the hose centerline, use total travel in the formula; i.e., $2 \times "T"$
- The offset distance "T" for constant flexing should never exceed 25 percent of the centerline bend radius "R."
- If the difference between "L" and "Lp" is significant, exercise care at installation to avoid stress on hose and braid at the maximum offset distance.

L = Live Hose Length (inches)

Lp = Projected Live Hose Length (inches)

R = Minimum Centerline Bend Radius – Dynamic (in.)

T = Offset Motion to One Side of Centerline (inches)

Flow Velocity Consideration

The flow velocity in corrugated metal hose should never exceed 150 ft./sec. for gas or 75 ft./sec. for liquids. When a hose is installed in a bent condition, the flow values should be reduced proportionally to the degree of the bend. Where the flow velocity exceeds these rates, an interlocked metal hose liner or larger hose I.D. is recommended.

Minimum Bend Radius Occurs at Offset Position

Moving end is free to move "out of line" at neutral position.

To find the live hose length:

Minimum Bend Radius Occurs at Crowded Position

Moving end of hose is restricted to move only up and down as hose crosses neutral position.

To find the live hose length:

Traveling Loops

In a piping system where axial movement must be accommodated or where the magnitude of the motion is in excess of the limits of an offset movement, the traveling loop configuration offers an ideal solution. In traveling loops, the centerline of a hose assembly is bent in a circular arc. Traveling loops accommodate movement in one of two ways. A constant radius traveling loop accommodates motion by varying the length of the arms of the assembly while the radius remains

$$L = \sqrt{6(RT) + T^2}$$

$$Lp = \sqrt{L^2 - T^2}$$

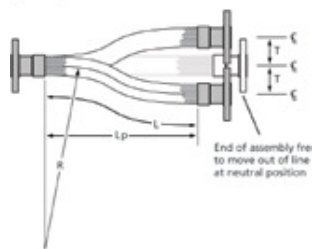

constant. A variable radius traveling loop accommodates motion by varying the bend radius of the hose assembly. Both types of traveling loops can be installed to absorb either horizontal or vertical movement. The constant radius traveling loop provides for greater movement while the variable radius traveling loop requires less installation space.

Traveling Loops

L = Live Hose Length (inches)

R = Minimum Centerline Bend Radius for Constant Flexing (inches)

T = Total Travel (inches)

H = Hang Length of the Loop (inches)

Classification of Motion (continued)

Constant Radius Traveling Loop – Class A

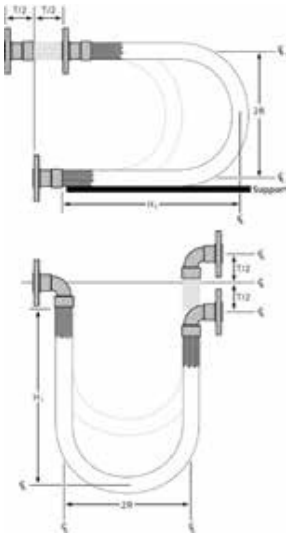

$$L = 4R + T/2$$

$$H1 = 1.43R + T/2$$

Penflex corrugated hose is engineered to provide maximum service life when properly installed. Improper installation, incorrect flexing or careless handling in an application will reduce the effective service life of the hose and cause premature failure of an assembly. The following installation and handling precautions should be observed to achieve optimum performance from your corrugated hose assemblies.

Avoid torque.

Do not twist the hose assembly during installation when aligning the bolt holes in a flange or in making up pipe threads. The utilization of lap joint flanges or pipe unions will minimize this condition. It is recommended that two wrenches be used in making the union connection; one to prevent the hose from twisting and the other to tighten the coupling.

In plane lateral offset installation

Prevent out-of-plane flexing in an installation. Always install the hose so that the flexing takes place in only one plane. This plane must be the plane in which the bending occurs.

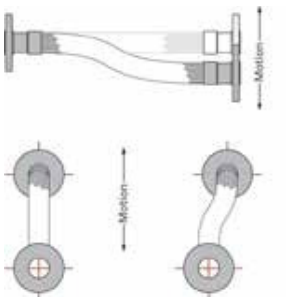

Correct
in plane
flexing

Wrong
out of plane
flexing

Variable Radius Traveling Loop – Class B

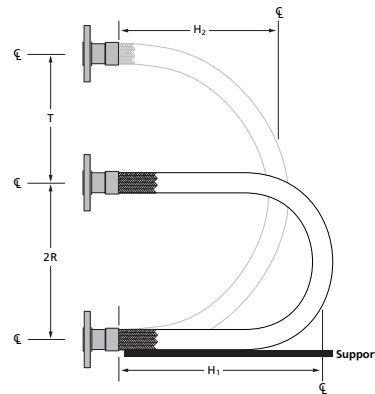

$$L = 4R + 1.57T$$

$$H1 = 1.43R + 0.79T$$

$$H2 = 1.43R + 0.5T$$

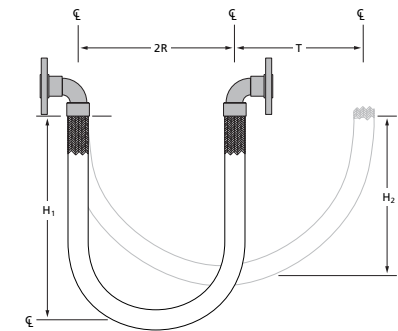

In plane traveling loop installation

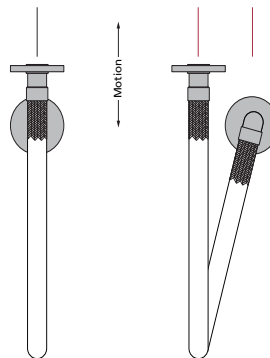
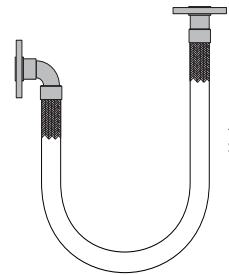

Correct
in plane
flexing

Wrong
out of plane
flexing

Assembly Installation (continued)

Avoid over bending.

The repetitive bending of a hose to a radius smaller than the radius listed in the specification tables for corrugated hose will result in premature hose failure. Always provide sufficient length to prevent over bending and to eliminate strain on the hose.

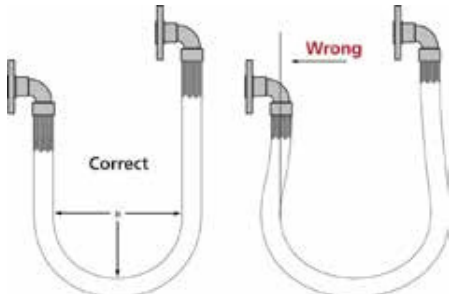

Provide support.

When installing the assembly in a horizontal loop, provide support for the arms to prevent the hose from sagging.

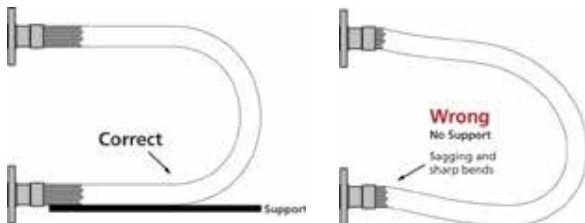

Handle with care.

Avoid careless handling of the hose assembly. Always lift or carry metal hose to prevent abrasion damage particularly to braided corrugated hose. Store metal hose assemblies away from areas where it can be subjected to spillage, corrosive fumes or sprays, weld splatter, etc.

Avoid sharp bends.

Utilize sound geometric configurations that avoid sharp bends, especially near the end fittings of the assembly.

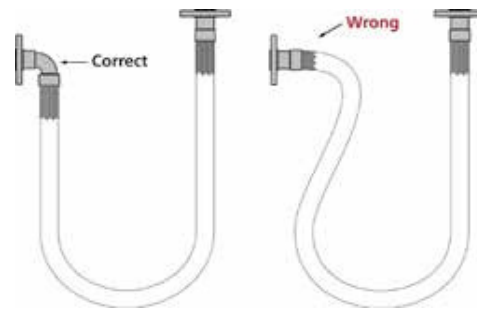

Do not extend or compress axially.

A piping system which utilizes metal hose to absorb movement must be properly anchored and/or guided.

Always support the piping to prevent excessive weight from compressing the hose and relaxing the braid tension.

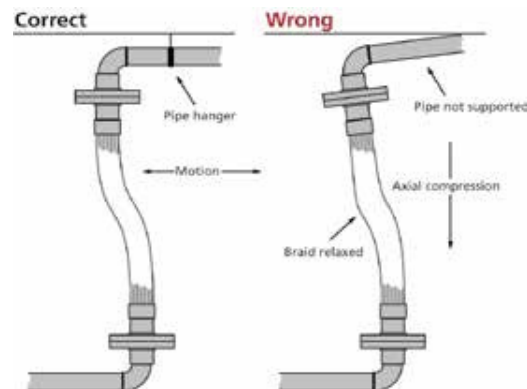

Maximizing the Safety and Effectiveness of an Assembly

Do...

- follow any printed instructions included with the flexible connector.
- follow industry-recommended practices and use care in handling and installing flexible connector.
- install flexible connectors so that the bend is as close to the center of the connector as possible.
- observe the minimum bend radius as specified by the connector manufacturer.
- trial-fit threaded connections by hand, unmake and then make permanent.
- use a flexible connector of proper length to suit the installation.
- only wrench on the fitting hex flats as provided.
- design the installation to allow for ground movement after installation, such as settling or frost heave.
- install the proper length connector to allow a 2" straight run of hose at each end fitting.
- use pipe wrenches on both mating hexes to avoid twisting the hose.
- keep hose free from all objects and debris.
- handle and store connectors carefully prior to installation.

- check for leaks before covering the installation.

- install in such a manner that the connector can be removed.
- make sure the pressure rating of connector is not exceeded.

Don't...

- apply a wrench to a hose, collar or assembly.
- twist hose assemblies during installation or when aligning the bolt holes in a flange or when making up pipe threads.
- "pre-flex" a flexible connector to limber it up. Over-bending could cause damage and result in leakage.
- over-bend a flexible connector. A 45°-90° bend should be sufficient to install any flexible connector.
- install a flexible connector with the bend next to the end fittings. This could cause damage and result in leakage.
- lay the flexible connector on rocks or objects which could puncture the hose and cause leakage.
- attempt to stretch or compress a flexible connector to fit an installation.
- restrict flexibility by allowing connector to come into contact with other components or equipment during installation.

Glossary

Abrasion: External damage to a hose assembly caused by its being rubbed on a foreign object.

Ambient or Atmospheric Conditions: The surrounding conditions, such as temperature, pressure and corrosion, to which a hose assembly is exposed.

Amplitude of Vibration and/or Lateral Movement: The distance a hose assembly deflects laterally to one side from its normal position, when this deflection occurs on both sides of the normal hose centerline.

Anchor: A restraint applied to a pipeline to control its motion caused by thermal growth.

Annular: Refers to the convolutions on a hose that are a series of complete circles or rings located at right angle to the longitudinal axis of the hose (sometimes referred to as bellows).

Application: The service conditions that determine how a metal hose assembly will be used.

Armor or Casing: Flexible interlocked tubing placed over the entire length or in short lengths at the end of a metal hose to protect it from physical damage and to limit the bending radius.

Attachment: The method of fixing end fittings to flexible metal hose – welding, brazing, soldering, swaging or mechanical.

Axial Movement: Compression or elongation of the hose along its longitudinal axis.

Basket Weave: A braid pattern in which the strands of wire alternately cross over and under two braid bands (two over – two under).

Bend Radius: The radius of a bend measured to the hose centerline.

Braid: A flexible wire sheath surrounding a metal hose that prevents the hose from elongation due to internal pressure. Braid is composed of a number of wires wrapped helically around the hose while at the same time going under and over each other in a basket-weave fashion.

Braid Angle: The acute angle formed by the braid strands and the axis of the hose.

Braid Construction: Term applies to description of braid, i.e., 36 x 8 x .014, 304L SS.

36 = number of carriers or bands in a braid

8 = number of wires on each carrier

.014 = wire diameter in inches

304L = material, Type 304L stainless steel

Braid Sleeve, Braid Band or Ferrule: A ring made from tube or metal strip placed over the ends of a braided hose to contain the braid wires for attachment of fittings.

Braid Wear: Motion between the braid and corrugated hose which normally causes wear on the O.D. of hose.

Braided Braid: In this braid, the strands of wire on each carrier of the braiding machine are braided together, and then braided in normal fashion, hence the term braided braid.

Brazing: A process of joining metals using a non-ferrous filler metal, which melts above 800°F, yet less than the melting of the “parent metals” to be joined.

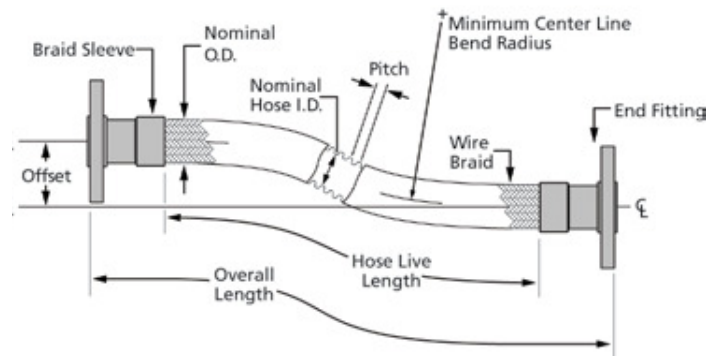

Butt Weld: A process in which the edges or ends of metal sections are butted together and joined by welding.

Casing: (See definition under Armor)

Controlled Flexing: Controlled flexing occurs when the hose is being flexed regularly, as in connections to moving components. Examples: Platen presses, thermal growth in pipe work.

Convolution: The annular or helical flexing member in corrugated or strip wound hose.

Corrosion: The chemical or electro-chemical attack of a media upon a hose assembly.

Cycle-Motion: The movement from normal to extreme position and return.

Developed Length: The length of a hose plus fitting (overall) required to meet the conditions of a specific application.

Diamond Weave: A braid pattern in which the strands alternately cross over one and under one of the strands (one over – one under). Also known as plain weave.

Dye Penetrant Inspection or Test: A method for detecting surface irregularities, such as cracks, voids, porosity, etc. The surface to be checked is coated with a red dye that will penetrate existing defects. Dye is removed from surface and a white developer is applied. If there is a defect in the surface being checked, the red dye remaining in it causes the white developer to be stained, thereby locating the defective area.

Displacement: The amount of motion applied to a hose defined as inches for parallel offset and degrees for radial misalignment.

Dog-Leg Assembly: Two hose assemblies joined by a common elbow.

Duplex Assembly: An assembly consisting of two hose assemblies – one inside the other – and connected at the ends.

Effective Thrust Area – Hose and Bellows: The cross-sectional area described by the outside diameter (at the tops of the convolutions) less two times the metal thickness of the hose or bellows.

Elastic (Intermittent Flexure): The smallest radius that a given hose can be bent to without permanent deformation of the metal in its flexing members (convolutions or corrugations).

Erosion: The wearing away of the inside convolutions of a hose caused by the flow of the media conveyed, such as wet steam, abrasive particles, etc.

Exposed Length: The amount of active (exposed) hose in an assembly. Does not include the length of fittings and ferrules.

Fatigue: Failure of the metal structure associated with, or due to, the flexing of metal hose or bellows.

Ferrule: (See definition for Braid Sleeve)

Fitting: A loose term applied to the nipple, flange, union, etc., attached to the end of a metal hose.

Flat Braid: Has a braid angle greater than 45° (See Braid Angle).

Flow Rate: Pertains to a volume of media being conveyed in a given time period, e.g., cubic feet per hour, pounds per second, gallons per minute, etc.

Frequency: The rate of vibration or flexure of a hose in a given time period, e.g., cycles per second (CPS), cycles per minute (CPM), cycles per day (CPD), etc.

Galvanic Corrosion: Corrosion that occurs on the less noble of two dissimilar metals in direct contact with each other in an electrolyte, e.g., water, sodium chloride in solution, sulphuric acid, etc.

Guide (For Piping): A device that supports a pipe radially in all directions, but allows free longitudinal movement.

Hardware: A loose term used to describe parts of a hose assembly other than the hose and braid, e.g., fittings, collars, valves, etc.

Helical: Used to describe a type of corrugated hose having one continuous convolution resembling a screw thread.

Helical Wire Armor: To provide additional protection against abrasion under rough operating conditions, metal hoses can be supplied with an external round or oval section wire spiral.

Inside Diameter: This refers to the free cross section of the hose and (in most cases) is identical to the nominal diameter.

Installation: Referring to the installed geometry of a hose assembly.

Interlocked Hose: Formed from profiled strip and wound into flexible metal tubing with no subsequent welding, brazing, or soldering. May be made pressure-tight by winding in strands of packing.

Intermittent Bend Radius: The designation for a radius used for non-continuous operation. Usually an elastic radius.

Lap Weld (LW): Type of weld in which the ends or edges of the metal overlap each other and are welded together.

Liner: Flexible sleeve used to line the I.D. of hose when the velocity of gaseous media is in excess of 180 ft. per second.

Loop Installation: The assembly is installed in a loop or "U" shape, and is most often used when frequent and/or large amounts of motion are involved.

Mechanical Fitting or Reusable Fitting: A fitting not permanently attached to a hose which can be disassembled and used again.

Medium (Singular)/Media (Plural): The substance(s) being conveyed through a piping system.

Minimum Bend Radius: The smallest radius to which a hose can be bent without suffering permanent deformation of its convolutions.

Misalignment: A condition in which two points, intended to be connected, will not mate due to their being laterally out of line with each other.

Nominal Diameter: A term used to define the dimensions of a

component. It indicates the approximate inside diameter.

Offset – Lateral, Parallel, & Shear: The amount that the ends of a hose assembly are displaced laterally in relation to each other as the result of connecting two misaligned terminations in a piping system, or intermittent flexure required in a hose application.

Operating Conditions: The pressure, temperature, motion, media, and environment that a hose assembly is subjected to.

Outside Diameter: This refers to the external diameter of a metal hose, measured from the top of the corrugation or braiding.

Penetration (Weld): The percentage of wall thickness of the two parts to be joined that is fused into the weld pool in making a joint. Our standard for penetration of the weld is 100 percent, in which the weld goes completely through the parent metal of the parts to be joined and is visible on the opposite side from which the weld was made.

Percent Of Braid Coverage: The percent of the surface area of a hose that is covered by braid.

Permanent Bend: A short radius bend in a hose assembly used to compensate for misalignment of rigid piping, or where the hose is used as an elbow. Hose so installed may be subjected to minor and/or infrequent vibration or movement.

Pipe Gap: The open space between adjacent ends of two pipes in which a hose assembly may be installed.

Pitch: The distance between the two peaks of adjacent corrugation.

Ply, Plies: The number of individual thicknesses of metal used in the construction of the wall of a corrugated hose.

Pressure: Usually expressed in pounds per square inch (PSI) and, depending on service conditions, may be applied internally or externally to a hose.

a. **Absolute Pressure** – A total pressure measurement system in which atmospheric pressure (at sea level) is added to the gage pressure, and is expressed as PSIA.

b. **Atmospheric Pressure** – The pressure of the atmosphere at sea level which is 14.7 PSI, or 29.92 inches of mercury.

c. **Burst Pressure (Actual And Rated)**

1. **Actual** – Failure of the hose determined by the laboratory test in which the braid fails in tensile, or the hose ruptures, or both, due to the internal pressure applied. This test is usually conducted at room temperature with the assembly in a straight line, but for special applications, can be conducted at elevated temperatures and various configurations.

2. **Rated** – A burst value which may be theoretical, or a percentage of the actual burst pressure developed by laboratory test. It is expected that, infrequently, due to manufacturing limitations, an assembly may burst at this pressure, but would most often burst at a pressure greater than this.

d. **Deformation Pressure (Collapse)** – The pressure at which the corrugations of a hose are permanently deformed due to fluid pressure applied internally, or, in special applications, externally.

e. **Feet of Water or Head Pressure** – Often used to express system pressure in terms of water column height. A column of water 1 ft. high exerts a .434 PSI pressure at its base.

Glossary (continued)

f. Proof Pressure or Test Pressure – The maximum internal pressure which a hose can be subjected to without either deforming the corrugations, or exceeding 50 percent of the burst pressure. When a hose assembly is tested above 50 percent of its burst pressure, there often is a permanent change in the overall length of the assembly, which may be undesirable for certain applications.

g. PSIA – Pounds per square inch absolute.

h. PSIG – Pounds per square inch gauge.

i. Pulsating Pressure – A rapid change in pressure above and below the normal base pressure, usually associated with reciprocating type pumps. This pulsating pressure can cause excessive wear between the braid and the tops of the hose corrugations.

j. Shock Pressure – A sudden increase of pressure in hydraulic or pneumatic system, which produces a shock wave. This shock can cause severe permanent deformation of the corrugations in a hose as well as rapid failure of the assembly due to metal fatigue.

k. Static Pressure – A non-changing constant pressure.

l. Working Pressure – The pressure, usually internal, but sometimes external, imposed on a hose during operating conditions.

Profile: Used in reference to the contour rolled into strip during the process of manufacturing stripwound hose, or the finished shape of a corrugation; formed from a tube by either the “bump-out”, “sink” or roll forming processes, used in making corrugated hose.

Random Motion: The non-cyclic uncontrolled motion of a metal hose, such as occurs in manual handling.

Reusable Fitting: (See Mechanical Fitting)

Safety Factor: The relationship of working pressure to burst pressure.

Scale: Generally refers to the oxide in a hose assembly brought about by surface conditions or welding. An oxide.

Seamless: Used in reference to a corrugated metal hose made from a base tube that does not have a longitudinal seam as in the case of a butt welded or lap welded tube.

Squirm: A form of failure in which the hose is deformed into an “S” or “U” bend as the result of excessive internal pressure being applied or unbraided corrugated hose which has been axially compressed, loosening the braid, while the hose is pressurized. This is particularly true with long lengths of braided hose subjected to manual or mechanical handling.

Strand(s): Individual groups of wires in a braid. Each group is supplied from a separate carrier in the braiding machine.

Stress Corrosion: A form of corrosion in stainless steel normally associated with chlorides.

Tig Weld: The tungsten insert gas welding process sometimes referred to as shielded arc. The common trade name is heliarc.

Traveling Loop: A general classification of bending, wherein the hose is installed to a U-shaped configuration.

1. Class A Loop – An application wherein the radius remains constant and one end of the hose moves parallel to the other end of the hose.

2. Class B Loop – A condition wherein a hose is installed in a U-shaped configuration and the ends move perpendicular to each other so as to enlarge or decrease the width of the loop.

Torque (Torsion): A force that produces, or tends to produce, rotation of or torsion through one end of a hose assembly while the other end is fixed.

Velocity: The speed at which the medium flows through the hose, usually specified in feet per second.

Velocity Resonance: The sympathetic vibration of convolutions due to buffeting of high velocity gas or air flow.

Vibration: Low amplitude motion occurring at high frequency.

Welding: The process of localized join of two or more metallic components by means of heating their surfaces to a state of fusion, or by fusion with the use of additional filler materials.



Since 1902, Penflex has been a leader in the design, manufacture and application of flexible metal hose and braid products.

